



# PLAYA



## **PLV**

**EXPOSITORES CARPETAS LED**

**MARCOS TERMINADOS**

**SOPORTES / TENSIÓN**

**SOPORTES / SEPARADORES**

**SOPORTES / SUJETAPLACAS**

**PORTAFOLLETOS**

**PANEL EMERGENTE**

**DYSPLAYS**

# EXPOSITORES CARPETAS LED

## CARPETAS LED

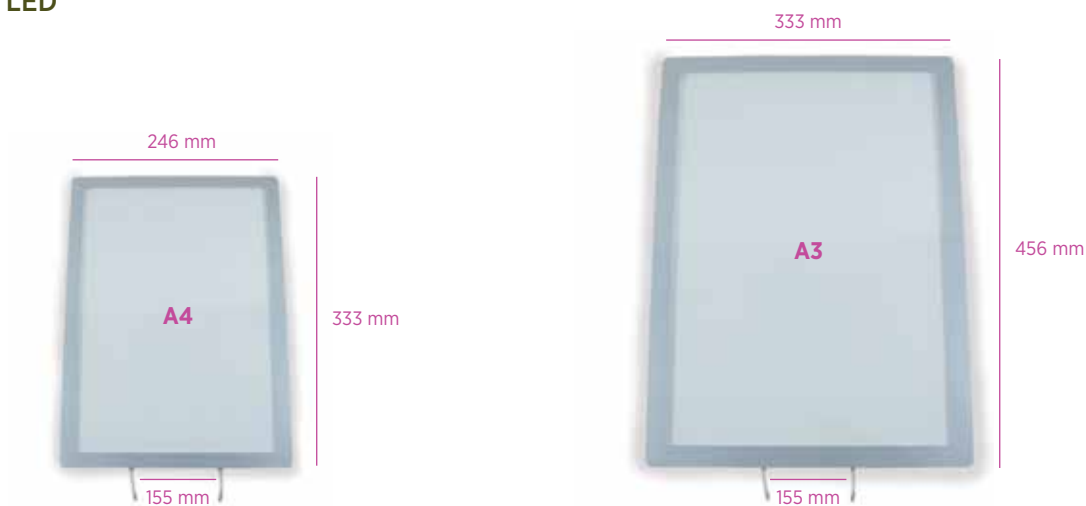

Referencia	Color	Voltios	Wattios	Flujo luminoso	Tamaño	Medidas carpeta	Medidas ventana	€/unidad
CLA4	BLANCO 8000-10000	24 V	7 W	3000 lm	A4	333 x 246 x 8	291 x 204	55,58
CLA3			13 W		A3	456 x 333 x 8	414 x 291	81,25

## KIT COLGADORES DE ALIMENTACIÓN

2 soportes + 2 m. de cable



Referencia	€/kit
KSA	15,41

## KIT PERFIL ELECTRIFICADO

Rail 1,1 m. + 2 tapas + cable de alimentación



Referencia	€/kit
KPE	28,70



## MARCO CON LUZ (LED)

### MARCO 20 MM.

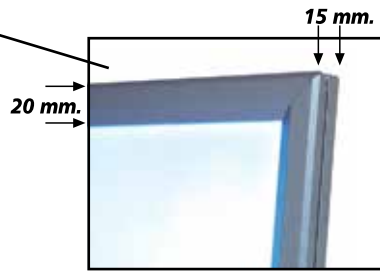

- 1 CARA
- **ESPEJOR 15 mm.**
- **PLÁSTICO PROTECTOR**

Referencia	Formato Imagen	Tamaño Ventana mm.	Medidas (x/y) exteriores mm.	Peso kg.	Medidas embalaje mm.	€/unidad
RILL1557	510 x 710	500 x 700	540 x 740	0,30	540 x 15 x 740	<b>180,79</b>

## MARCO CON LUZ (TUBOS TS)

### 56 MM. ESQUINA INGLETE

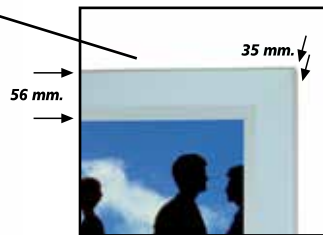

- 1 CARA
- **ESPEJOR 35 mm.**
- **PLÁSTICO PROTECTOR**

Referencia	Formato Imagen	Tamaño Ventana mm.	Medidas (x/y) exteriores mm.	Peso kg.	Medidas embalaje mm.	€/unidad
RIT53557	540 x 72	510 x 695	620 x 805	0,30	620 x 35 x 805	<b>206,04</b>
RIT535710	740 x 1025	710 x 995	820 x 1105	0,55	820 x 35 x 1105	<b>301,00</b>

### 52 MM. ESQUINA INGLETE

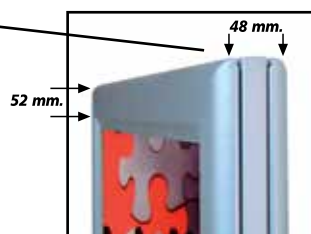

- 2 CARAS
- **ESPEJOR 48 mm.**
- **PLÁSTICO PROTECTOR**

Referencia	Formato Imagen	Tamaño Ventana mm.	Medidas (x/y) exteriores mm.	Peso kg.	Medidas embalaje mm.	€/unidad
R2T54857	510 x 710	500 x 700	540 x 740	0,30	540 x 48 x 740	<b>311,76</b>
R2T548710	710 x 1010	700 x 1000	740 x 1040	0,55	740 x 48 x 1040	<b>496,30</b>

# MARCO CON LUZ (TUBOS TS)

## CABALLETE

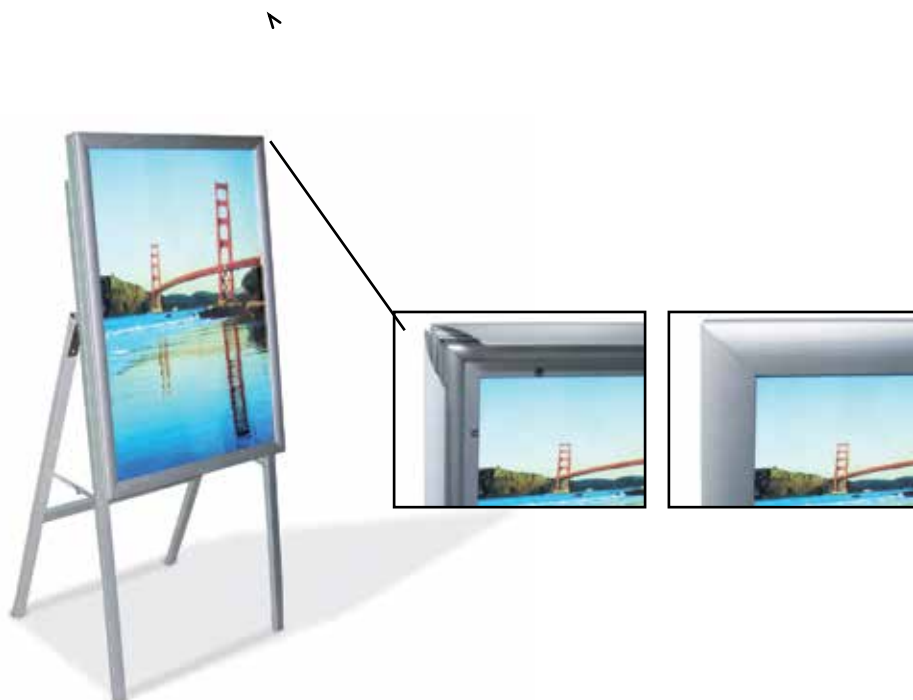

- MARCO 32 mm.
- MARCO ABATIBLE
- ESQUINA INGLETE

Referencia	Formato Imagen	Tamaño Ventana mm.	Medidas (x/y) exteriores mm.	Iluminación	Medidas embalaje mm.	€/unidad
KCMAL3257	510 x 710	500 x 700	570 x 770	1 CARA	570 x 50 x 770	142,45

## DE TECHO

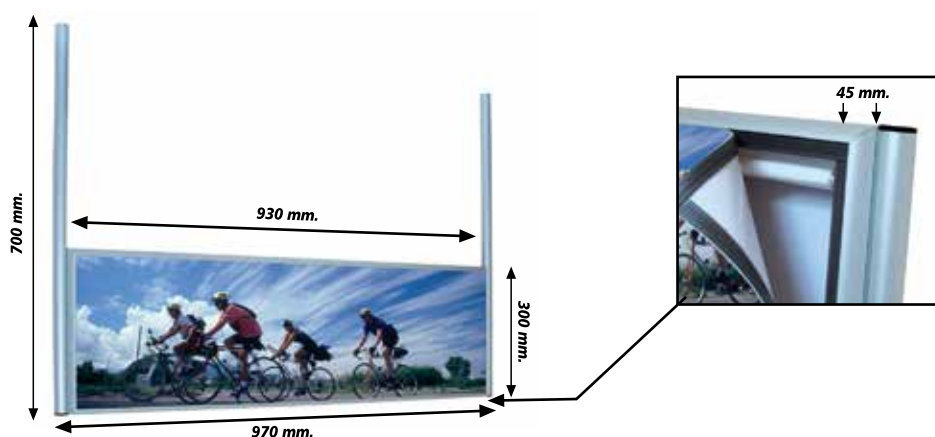

- 2 CARAS
- ESPESOR 45 mm.
- METACRILATO CON BANDA MAGNÉTICA

Referencia	Formato Imagen	Tamaño Ventana mm.	Medidas (x/y) exteriores mm.	Peso kg.	Medidas embalaje mm.	€/unidad
RTT54539	905 x 275	905 x 275	930 x 300	0,55	930 x 45 x 275	98,54

## SUJETA PLACAS SIMPLE



Referencia	Color		€/caja
CSPSOR	ORO	4	15,24
CSPSCR	CROMO	4	16,01
CSPSPLS	PLATA	4	16,91

## SUJETA PLACAS DOBLE



Referencia	Color		€/caja
CSPDOR	ORO	2	10,95
CSPDCR	CROMO	2	11,45
CSPDPLS	PLATA	2	11,98



## SOPORTE TENSIÓN

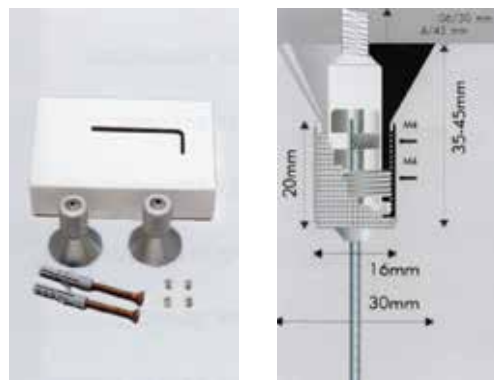

Referencia	Color		€/caja
STOR	ORO	2	17,90
STCR	CROMO	2	18,62
STPLS	PLATA	2	20,33

## SOPORTE TENSIÓN MÓVIL



Referencia	Color		€/caja
STMOR	ORO	2	25,33
STMCR	CROMO	2	27,39
STMPLS	PLATA	2	31,89

## PEQUEÑO



Referencia	Color		€/caja
SOSPOR	ORO	8	28,93
SOSPCR	CROMO	8	21,83
SOSPPLS	PLATA	8	28,50

## MEDIANO



Referencia	Color		€/caja
SOSMOR	ORO	4	14,89
SOSMCR	CROMO	4	11,13
SOSMPLS	PLATA	4	13,23



## GRANDE



Referencia	Color		€/caja
SOSGOR	ORO	4	35,31
SOSGCR	CROMO	4	28,75
SOSGPLS	PLATA	4	35,53

## LATERAL



Referencia	Color		€/caja
SOSLCR	CROMO	4	30,94
SOSLPLS	PLATA	4	36,32

## ACERO 15

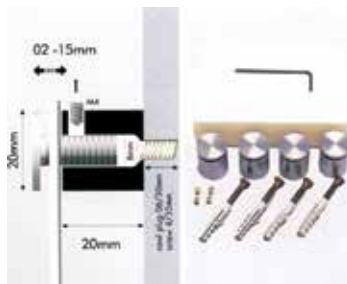

Referencia	Color		€/caja
SSA15	PLATA	4	13,91

## ACERO 20



Referencia	Color		€/caja
SSA20	ACERO	4	18,40

## GRUESO VARIABLE



Referencia	Color		€/caja
SSPGOR	ORO	4	29,45
SSPGCR	CROMO	4	37,27
SSPGPLS	PLATA	4	40,66

## PLÁSTICO



Referencia	Color		€/caja
SSPT	TRANSPARENTE	4	6,21
SSPN	NEGRO	4	5,91
SSPG	GRIS	4	5,91
SSPB	BLANCO	4	5,91
SSPC	CROMO	4	8,68
SSPP	PLATA	4	10,68

## SEPARADOR OCULTO

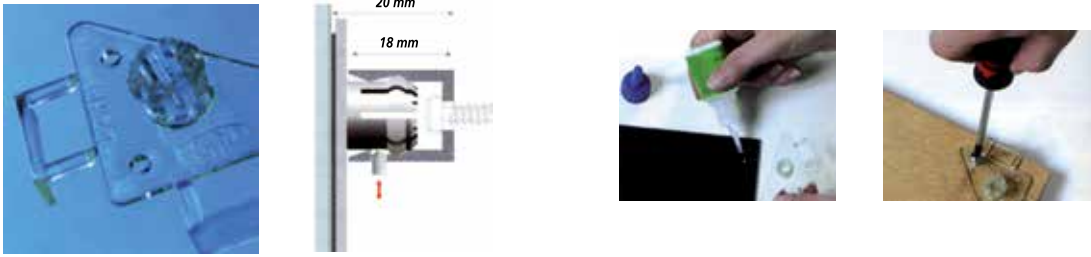

Referencia		€/caja
SSO	4	14,28

## PERFIL CARRIL

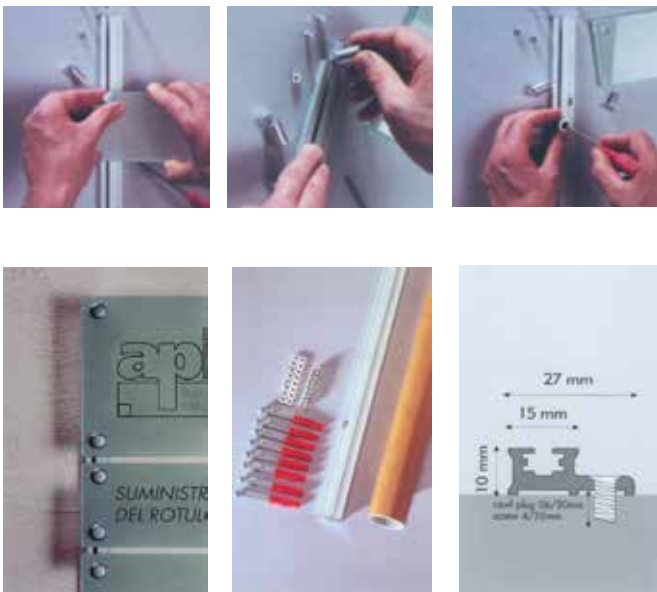

Referencia	Color	Metros/barra	€/metro
CA	ALUMINIO	1,4	22,16

## BOTÓN DE UNIÓN

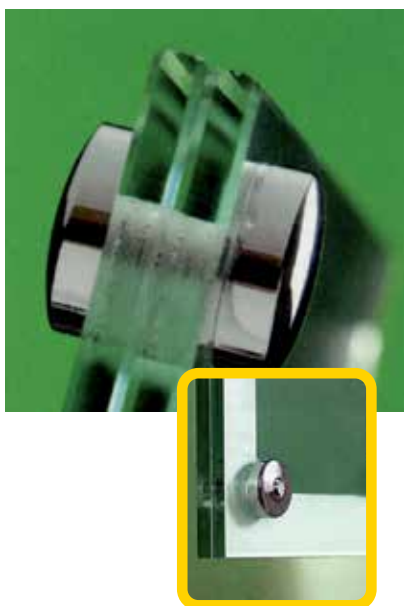

Referencia	Color		€/caja
SBUCR	CROMO	4	12,75
SBUPLS	PLATA	4	13,40

## SOPORTE PRESIÓN

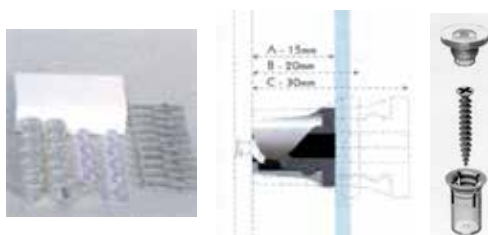

Referencia	Color	Medidas		€/caja
SP15	BLANCO	15 mm. Ø15 mm.	10	5,39
SP20	BLANCO	20 mm. Ø20 mm.	10	6,19
SP30	BLANCO	30 mm. Ø20 mm.	10	6,35

PRISIONERO ESFÉRICO



Referencia	Color		€/caja
PECR	CROMO	4	5,46

PRISIONERO CÓNICO



Referencia	Color		€/caja
PCPLS	PLATA	4	12,63

CABLE DE ACERO INOXIDABLE



Referencia	Metros/rollo	€/rollo
CAC	25	35,00



COLGADOR TORNILLO

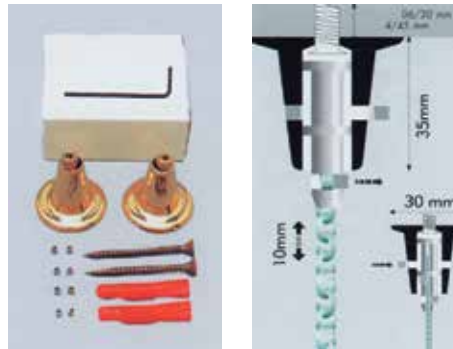

Referencia	Color		€/caja
SOTCOOR	ORO	2	8,42
SOTCOCR	CROMO	2	13,48
SOTCOPLS	PLATA	2	14,09

COLGANTE BOTELLA



Referencia	Color		€/caja
SOTCOR	ORO	2	8,69
SOTCCR	CROMO	2	11,19
SOTCPLS	PLATA	2	11,24

COLGADOR ACERO

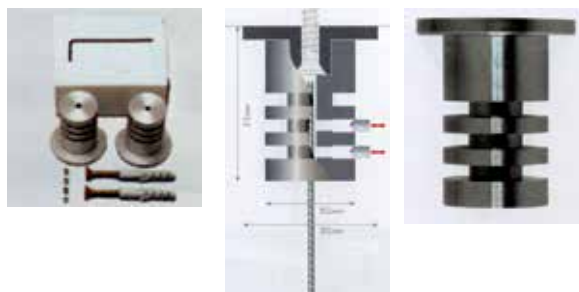
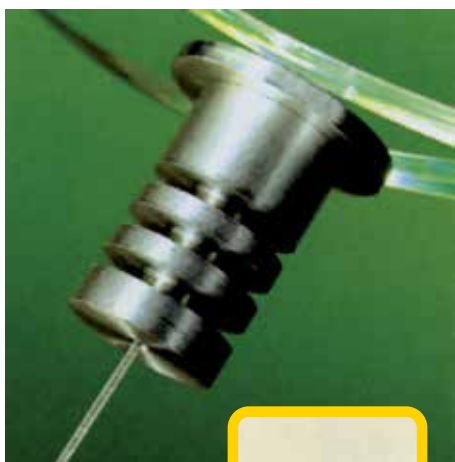

Referencia	Color		€/caja
SCOA	ACERO	2	28,89

COLGANTE ACERO

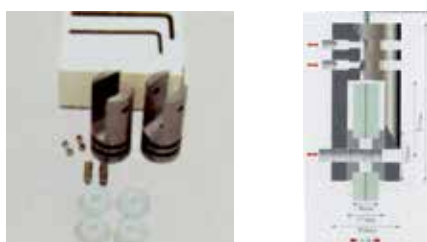

Referencia	Color		€/caja
SCA	ACERO	2	34,67

## COLGADOR GIRATORIO

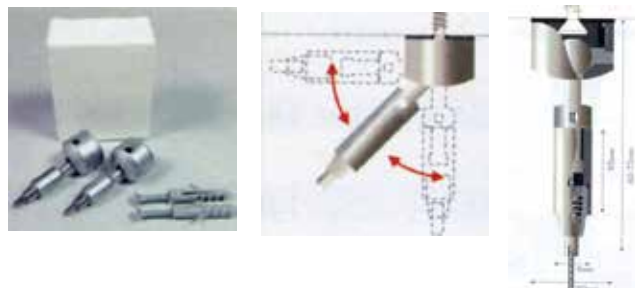
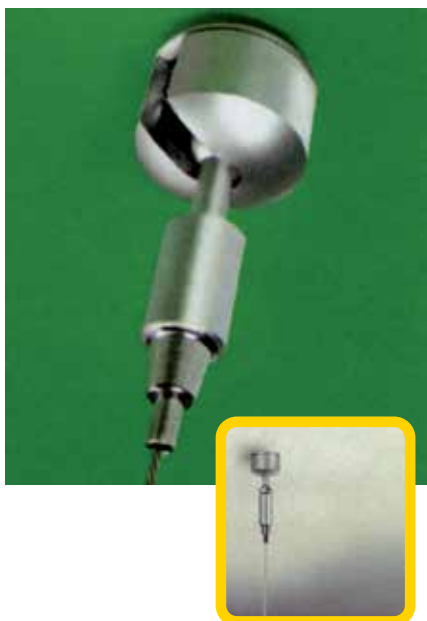

Referencia	Color		€/caja
SCOGPLS	PLATA	2	20,76

## COLGADOR AUTOMÁTICO

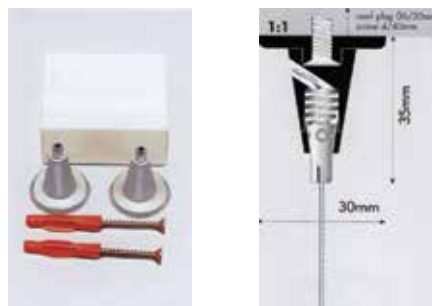

Referencia	Color		€/caja
SOTAOR	ORO	2	12,30
SOTACR	CROMO	2	16,90
SOTAPLS	PLATA	2	17,03

## COLGADOR BOTÓN



Referencia	Color		€/caja
SCOBPLS	PLATA	2	13,48

## COLGANTE DOBLE BOTÓN

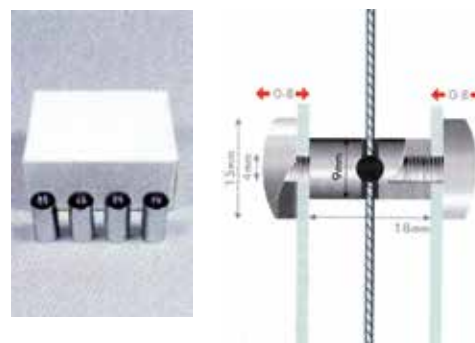

Referencia	Color		€/caja
SCDBPLS	PLATA	4	7,08

COLGANTE GANCHO

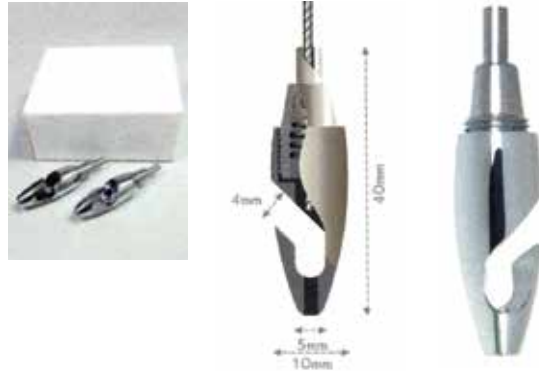

Referencia	Color		€/caja
SCGCR	CROMO	2	12,95

BANDEROLA BOTELLA

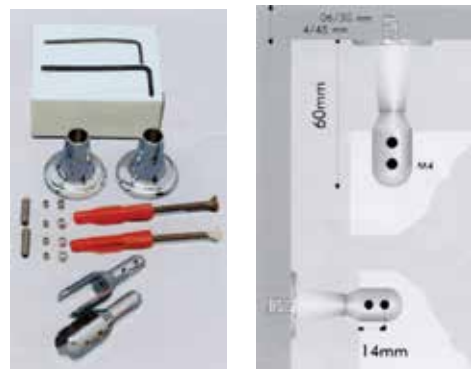

Referencia	Color		€/caja
SOBOR	ORO	2	13,38
SOBCR	CROMO	2	18,52
SOBPLS	PLATA	2	20,23

## BANDEROLA ACERO



Referencia	Color		€/caja
SBA	ACERO	2	42,37

## UNIÓN DOBLE BOTÓN

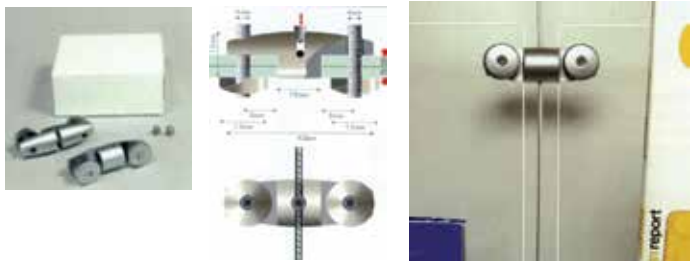
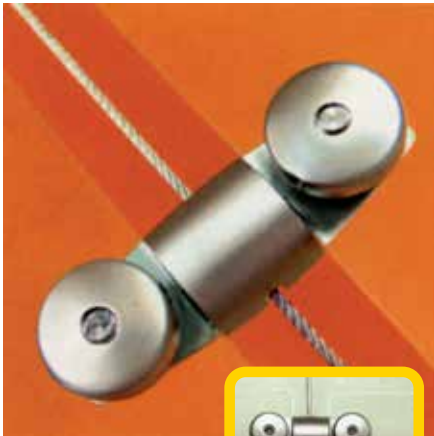

Referencia	Color		€/caja
SDBCR	CROMO	2	12,97
SDBPLS	PLATA	2	14,79



## UNIÓN DOBLE FLECHA

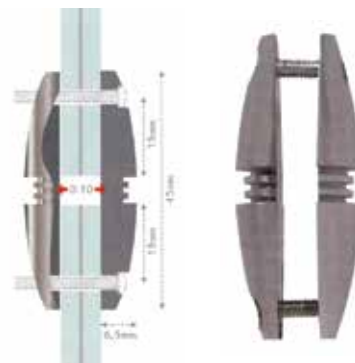

Referencia	Color		€/caja
SDFA	ACERO	2	25,74

## PORTAFOLLETOS



Referencia	Descripción	€/unidad
PA5H	DIN A-5 HORIZONTAL	12,75
PA4H	DIN A-4 HORIZONTAL	19,38
PA4V	DIN A-4 VERTICAL	10,43
P2A4V	2 x DIN A-4 VERTICAL	47,51
P3A4V	3 x DIN A-4 VERTICAL	63,76
PA3H	DIN A-3 HORIZONTAL	23,25
PA3V	DIN A-3 VERTICAL	20,97

# PORTAFOLLETOS ABATIBLE PLANO

PARA PARED O CRISTAL

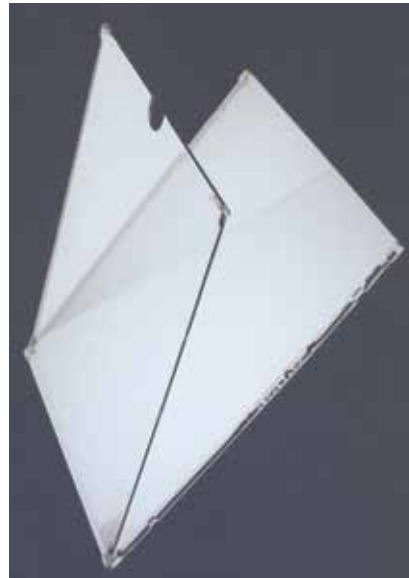

Referencia	Dimensiones		€/unidad
PAA4H	DIN A-4 HORIZONTAL	20	24,38
PAA4V	DIN A-4 VERTICAL	20	24,38
PAA5H	DIN A-5 HORIZONTAL	20	20,63
PAA5V	DIN A-5 VERTICAL	20	20,63

# PORTAFOLLETOS ABATIBLE CURVO

## PORTAFOLLETOS

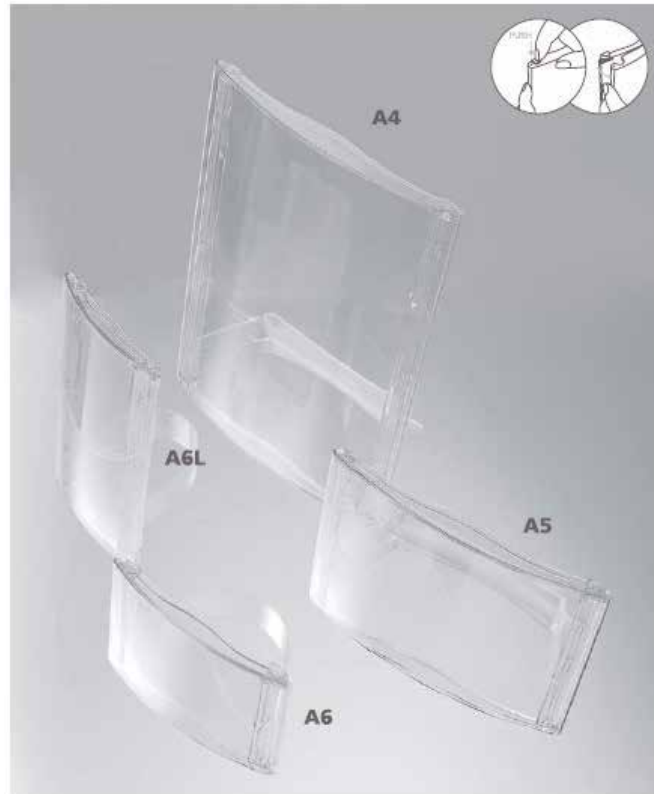

Referencia	Descripción	Tamaño	€/unidad
PAC4	Portafolletos	A4 (210x297)	21,83
PAC5	Portafolletos	A5 (148x210)	19,69
PAC6	Portafolletos	A6 (105x148)	13,80
PAC6L	Portafolletos	A6L (105x210)	16,59
SPAC	Soporte	-----	3,24



**PAC 4**



**PAC 5**



**PAC 6**



**PAC 6L**



**SPAC**

- Portafolletos
- Soporte
- Cinta adhesiva doble cara
- Tacos de fijación (2)

- Portafolletos
- Cinta adhesiva doble cara
- Tacos de fijación (2)

- Soporte

# PORTAFOLLETOS ABATIBLE CURVO

## CON ANCLAJE Y SOPORTE DE PIE

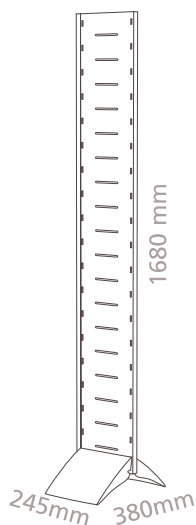

Referencia	Descripción	Tamaño	€/unidad
PCDO	Soporte de pie	245x380x1680 mm.	192,60
CAP4	Portafolletos con anclaje	A4 (Vertical)	28,46
CAP5	Portafolletos con anclaje	A5 (Horizontal)	21,40

## KIT DE PARED



### KSP

- Soporte de tensión (2)
- Tacos de fijación (2)
- Cable de acero
- Barra de suspensión



### PP4V

- Portafolletos A4 vertical



### KFP

- Soporte de tensión (4)
- Tacos de fijación (4)
- Cable de acero



### PP5H

- Portafolletos A5 horizontal



### SOFP

- Soporte de unión cable/portafolletos (4)

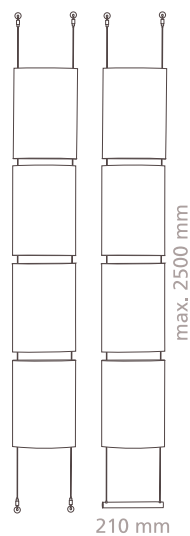

Referencia	Descripción	Tamaño	€/unidad
KSP	Kit suspensión	-----	57,78
KFP	Kit fijación	-----	66,20
SOFP	Caja soporte fijación (4 u.)	-----	21,68
PP4V	Portafolletos	A4 (Vertical)	19,58
PP5H	Portafolletos	A5 (Horizontal)	15,84

# PANEL EMERGENTE



## MAGNÉTICO CURVO A

Referencia	Medidas	€/unidad
MGA33	300 x 300 cm.	260,09
MGA34	300 x 400 cm.	348,90

## CAJA RÍGIDA



Referencia	€/unidad
CAJAMG	100,34

## MOSTRADOR DE MADERA



Referencia	€/unidad
MSM	208,60

## MARCO ABATIBLE



Referencia	Medidas	Tipo	€/unidad
YCL5	900 x 2000	1 Cara	<b>26,08</b>
YCL5D	900 x 2000	2 Caras	<b>38,22</b>



## ENROLLABLE CON MOVIMIENTO UNA CARA



Referencia	Medidas cm.	Luz	€/unidad
HK3	85 x 200	NO	<b>126,34</b>
HK3B	85 x 200	SI	<b>136,86</b>



## ENROLLABLE CON MOVIMIENTO DOBLE CARA



Referencia	Medidas cm.	Luz	€/unidad
HK4	85 x 200	NO	<b>141,08</b>
HK4B	85 x 200	SI	<b>185,30</b>





BANDERA MÓVIL

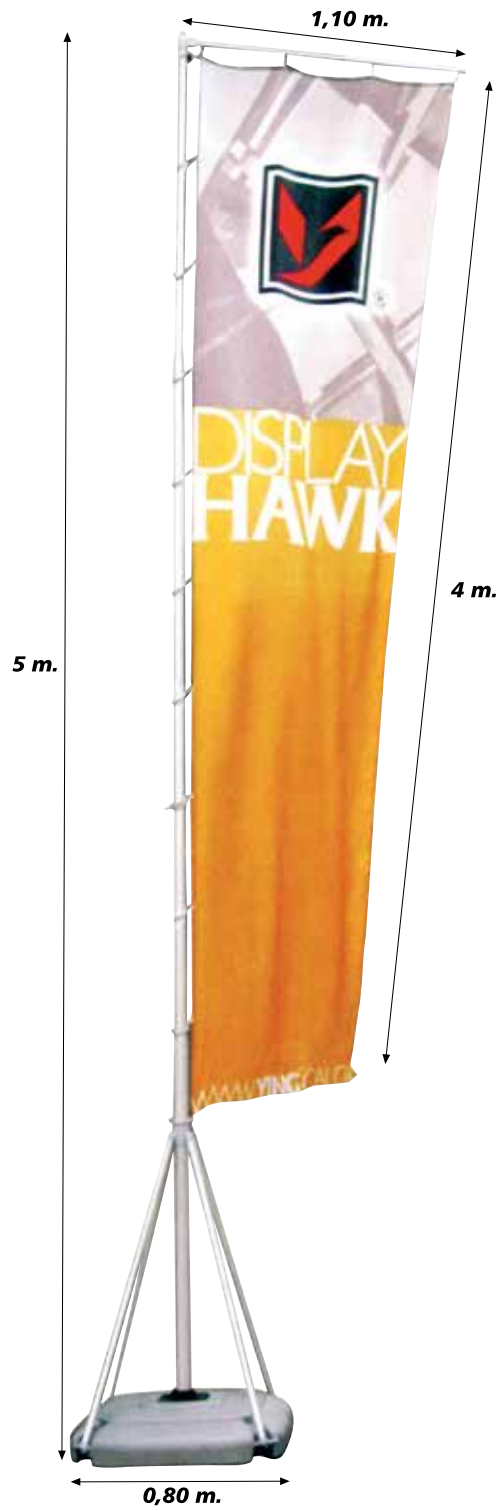

Referencia	€/unidad
MBM	122,50

# apil

C / Einstein, 11  
Pol. Ind. Sur M-50  
28914 Leganés (Madrid)

---

Tel.: 916 418 990  
Fax: 916 435 388

---

www.apil.es  
apil@apil.es